

EUDA2 SERIES

The Panel PC Made Easy

- Stylish
- Interactive
- Intelligent
- Flexible
- Fan-free
- Integrated



Fan-free Slim Panel PC with Low Power Intel® Atom™ Cedarview Dual Core D2550 1.86GHz

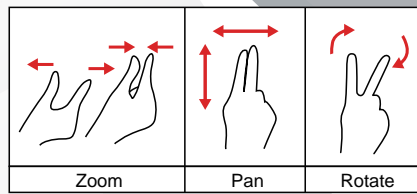

Interactive

- True Flat-touch Window
 - From 4:3 to 16:9 widescreen format
- Project capacitive multi-touch
 - 5-wire resistive single touch (customizable)
 - 7H Vandal proof surface against damage
 - Sensitivity, Precision & Durability
 - Glove operation (Medical glove)
 - Prevent operating errors (Security)



Stylish

- All-in-one Design
- Attractive Appearance
 - Stylish industrial design
 - Aluminum tooling enclosure
 - Painted & seamless assembly
 - Indentation of I/O from side view
 - Aesthetic design in mechanical parts
- Ultra Slim & Ultra Light (compact)

Intelligent

- HDD Tray & CF Cover
- Cable-less
- Easily Removable Back Cover
- RS-232/422/485 Selectable by BIOS
- Wide DC Input Range 12~24V
- Auto loss Power On



Flexible

- I/O Board Docking Design (Golden Finger Connector)



EUDA2 - S1220



2 x RS-232 / 422 / 485

Default



1 x Line-out
1 x RS-232 / 422 / 485



2 x USB
1 x Line-out

EUDA2-S1520 & EUDA2-S1821



2 x USB
2 x RS-232 / 422 / 485

Default



1 x RS-232
2 x RS-232 / 422 / 485

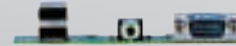

2 x USB
1 x Line-out
1 x RS-232 / 422 / 485

* The signals of Golden Finger interface:
(1)USB1.1/2.0 X2 (2)RS232X2 (3)RS232/422/2485X2 (4)Line out X1

Fan-free

- Optimal Placement Arrangement
 - Thermal simulation before HW is built
- Best Platform and Component Selection
 - Low power CPU (Cedar Trail)
 - Suitable electrical components that generate less heat
 - Aluminum tooling (front and back cover)
 - Suitable heat sink and thermal pad (dissipates heat quickly)
 - Longevity Support (CPU, No fan & Industrial Panel)

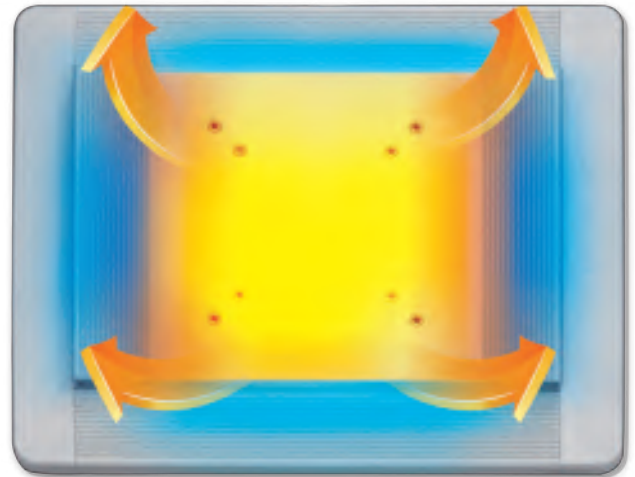

Integrated

- EtherCAT Support(Intel® 82574L Gigabit)
- Embedded OS and BIOS service(customizable)
- APIs(Provide default package and customizable)



*Automation network-control can recognize EUDA2 automatically (The LAN chip Intel® 82574L is in the EtherCAT solution approval list. The default driver is embedded in the OS and no more extra software efforts are needed).

Outline Dimension

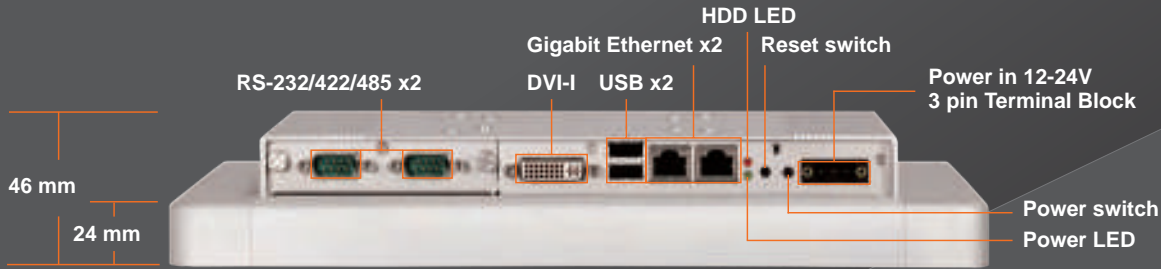

* The picture of EUDA2-S1220

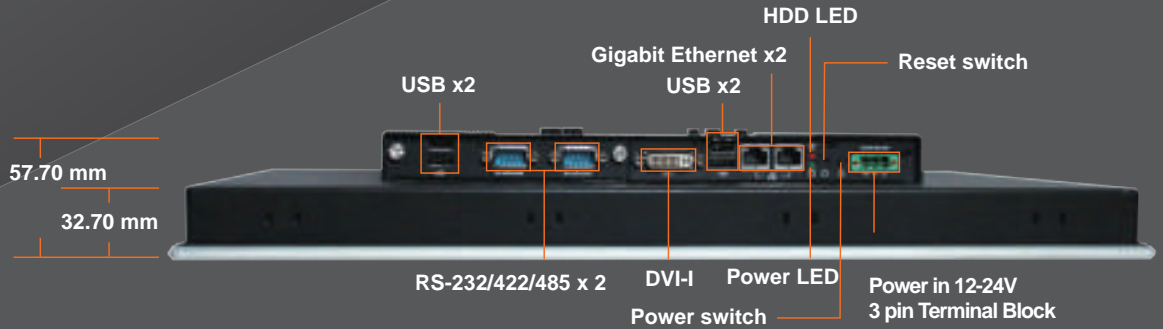

* The picture of EUDA2-S1821

EUDA2-S1220

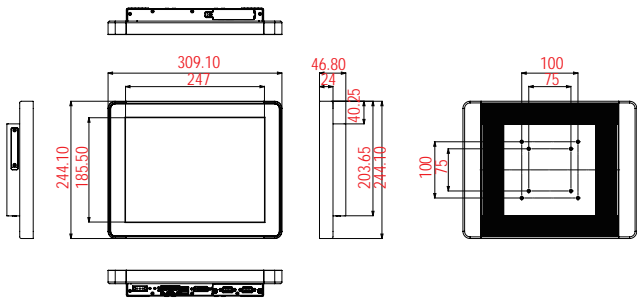

EUDA2-S1520

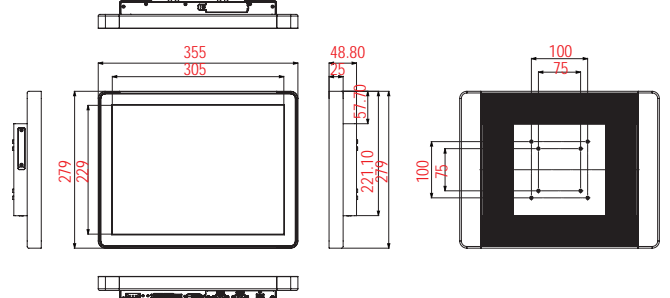

EUDA2-S1821

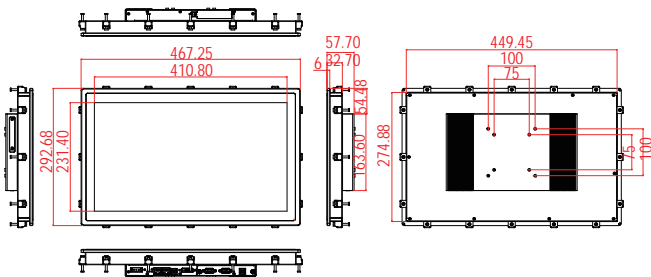

Cut Out Dimension

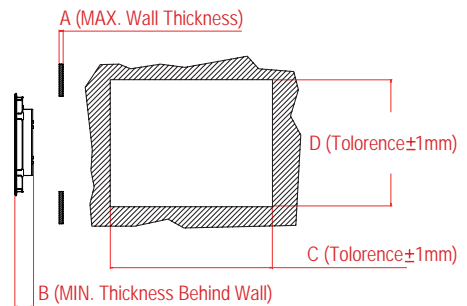

Accessory

Panel Mount Kits(Only for EUDA2-S1821)	16 pieces
HDD and HDD Tray(M3X4L) Screws	4 pieces
CD (Drivers and user's manual)	1 piece
3-Pin terminal block connector (Female)	1 piece

Optional (ATO)

Storage	2.5" SATA HDD &SSD,CF Card
Memory	DDR3 SO-DIMM SDRAM 1066-1333 MHZ, 30mi gold (1,2,4GB)
Adaptor Set	12V, 5A /60W Adaptor+3 pin terminal block cable
OS	Windows 7(32 bit) /WES 7(32 bit) (Label & OS installation)

	A (mm)	B (mm)	C (mm)	D (mm)	Mounting Kits (pcs)
EUDA2-S1821	<9	53.70	452	277	x16

EUDA2 Series

Model Name	EUDA2-S1220	EUDA2-S1520	EUDA2-S1821
Display			
LCD Size	12"(4:3)	15"(4:3)	18.5"(16:9)
Resolution	800x600	1024x768	1366x768
Brightness	450 cd/m2	400 cd/m2	300 cd/m2
Contrast Ratio	700: 1	700:01	1000:1
Backlight	LED type	LED type	LED type
Touch Screen	Projected Capacitive Multi-Touch; 5-Wire Resistive Single Touch (Customizable)		
System			
CPU	Intel® Atom™ Dual-Core D2550 1.86 GHz		
Chipset	Intel® NM10		
Memory	DDR3 SO-DIMM SDRM 1066-1333 MHz max up to 4GB		
BIOS	AMI BIOS		
Graphics	Intel® GMA 3650 Graphics		
LVDS	Dual Channel 24-bit		
LAN Chipset	Dual Intel® 82574L Gigabit Ethernet		
Audio	Realtek® High Definition Audio		
Watchdog Timer	1-255 levels reset		
Storage Device	2.5" SATA HDD/2.5" SATA SSD/ Compact Flash II up to 32GB		
OS	Windows 7(32 bit) /WES 7(32 bit) supported		
I/O Interface			
On Board	2 x Gigabit, 2 x USB, 1 x DVI-I (Default)		
Expansion (default)	2xRS-232/422/485	2xRS-232/422/485,2xUSB (Default)	
Expansion (option 1)	1xRS-232/422/485,1xLine-out	2xRS-232/422/485,1xRS-232	
Expansion (option 2)	2xUSB,1xLine-out	1xLine-out,1xRS-232/422/485,2xUSB	
Support Protocol	EtherCAT Support		
Mechanical			
Mounting	VESA Mount 75 x 75, 100 x 100		Panel & VESA Mount
Weight (Kg)(N)	3.8 Kg	4.0 Kg	6.8 Kg
Weight (Kg)(G)	5.8 Kg	7.0 Kg	9.7 Kg
Power			
Power Supply	DC 12 - 24V input (w/3 pin DC input terminal bock)		
Consumption (Max)	35W(12V);36W(24V)	39.2W(12V);40.0W(24V)	45.1W(12V);44.6W(24V)
Consumption (Min)	7.1W(12V);7.9W(24V)	7.3W(12V);7.9W(24V)	8.4W(12V);7.7W(24V)
Environmental			
OP /Storage	0 - 50°C (Operation); -20-60°C (Storage); (20-90%, non-condensing)		
Vibration	1.0G (CF) and 0.5G (HDD) , Power on & 2.16G, Packaged, 5-500Hz		
Shock	15G peak acceleration, 11 ms (Power on condition)		
Drop	Packaged with Carton from 96.5cm (1-Corner, 3-Axis, 6-Face)		
IP Protection	IP54 (Front) / IP20 (Rear) (IEC 60529 Edition 2.1 Standard)		IP65 (Front) / IP20 (Rear)
Certificate	CE/FCC Class A		



American Portwell (Fremont, California)

44200 Christy St.
Fremont, CA 94538, USA
Tel: +1-510-403-3389
Fax: +1-510-403-3184
E-mail: info@portwell.com
<http://www.portwell.com>

American Portwell (Norcross, Georgia)

5555 Oakbrook Parkway, Building 100
Suite 175, Norcross, GA 30093, USA
Tel: +1-878-989-9808
Fax: +1-878-989-9816
E-mail: info@portwell.com
<http://www.portwell.com>

Portwell Japan, Inc. (Tokyo)

〒101-0042 ShowaKanda Build 9F, 10-2
Kanda Higashi Matsushita-cho
Chiyoda-ku, Tokyo, Japan
Tel: +81-3-5298-8071
Fax: +81-3-5298-8072
E-mail: info@portwell.co.jp
<http://www.portwell.co.jp>

Portwell Japan, Inc. (Osaka)

〒532-0004 Ste. 501 Nippo Shin-osaka
Dai-2 Bldg, 1-8-33 Nishi-Miyahara,
Yodogawa-ku, Osaka, Japan
Tel: +81-6-4807-7721
Fax: +81-6-4807-7720
E-mail: info@portwell.co.jp
<http://www.portwell.co.jp>

Beijing Portwell

4F, Building 5, Quanying Zone,
Chuangye Rd, 8, Shangdi, Haidian
District, Beijing 100085, China
Tel: +86-10-8270-1616
Fax: +86-10-8270-0606
E-mail: info@portwell.com.cn
<http://www.portwell.com.cn>

Portwell, Inc. (Headquarters)

No. 242, Bo-Ai St., Shu-Lin Dist.,
New Taipei City 238, Taiwan
Tel: +886-2-77318888
Fax: +886-2-77319888
E-mail: info@portwell.com.tw
<http://www.portwell.com.tw>

Shanghai Portwell

Room 1908 Yin Fa Mansion,
No. 1068 West Beijing Road,
Shanghai 200041, P.R. China
Tel: +86-21-3222-0505
+86-21-3222-0606
Fax: +86-21-6256-8056
E-mail: info@portwell.com.cn
<http://www.portwell.com.cn>

Shenzhen Portwell

Hunting 4th Building 26F
#Modern City, Nanshan District
Shenzhen 518052, China
Tel: +86-755-8621-7695
+86-755-8622-6424
Fax: +86-755-8617-2084
E-mail: info@portwell.com.cn
<http://www.portwell.com.cn>

European Portwell

Haverstraat 10, Nieuw-Venneweg,
2153 GB, Netherlands
Tel: +31-252-620790
Fax: +31-252-621325
E-mail: info@portwell.nl
<http://www.portwell.nl>

Portwell (UK) Ltd.

Unit 15, Moorbrook,
Southmead Industrial Estate,
Didcot OX11 7HP, UK
Tel: +44(0)1235-750760
Fax: +44(0)1235-750761
E-mail: info@portwell.co.uk
<http://www.portwell.co.uk>

Portwell-Laxsons India

Laxsons House, AA2, Walbhat Road,
Goregaon (E), Mumbai - 400 063,
Maharashtra, India
Tel: +91-22-2685-9911
Fax: +91-22-2685-9922
E-mail: info@portwellaxsons.com
<http://www.portwellaxsons.com>